

APPLICATIONS

- Aquifer recharge and recovery.
- Saltwater intrusion, desalination, and wastewater.
- Wetland monitoring.
- Groundwater contamination monitoring.
Surface water monitoring.

ADVANTAGES

- Digital sensor communicates three measurements over a serial interface.
- Precision pressure transducer for water depth measurements.
- Accurate 4-probe EC measurement.
- Robust thermistor for accurate temperature measurements.
- Low input voltage requirements.
- Low power design supports battery-operated data loggers.
- Robust marine-grade epoxy encapsulation to resist corrosive environments.
- Stainless steel cover improves durability
- Supports SDI-12 or DDI-Serial 1-wire serial communications protocols.
- Modern design optimized for low-cost sensing.
- Differential pressure measurement is referenced to atmospheric pressure so no external pressure sensor is needed.

DESCRIPTION

The Decagon CTD sensor is a low-cost, accurate tool for monitoring water level, electrical conductivity, and temperature in both groundwater and surface water. The sensor employs a precision pressure transducer to sense water levels between 0 and 3.5 meters. The sensor cable is vented to remove the effects of barometric pressure changes. The integrated 4-probe electrical conductivity transducer accurately senses EC up to 120 mS/cm. The sensor also features an precision thermistor to measure temperature. The CTD has a compact 3.4 cm diameter body made of rugged Delrin. The electronic circuitry is encapsulated in a marine-grade epoxy to protect the sensor in corrosive environments.

AUDIENCE

Decagon provides the information in this integrators guide to help CTD customer establish communication between these sensors and their data acquisition equipment or field data loggers. Customers using data loggers that support SDI-12 sensor communications should consult the user's manual for their data logger. These sensors are fully integrated into Decagon's system of plug-and-play sensors, cellular-enabled data loggers, and data analysis software.

MEASUREMENT SPECIFICATIONS

	Depth @ 20°C	Temperature	Bulk Electrical Conductivity
Accuracy	±0.2% of full scale	±1°C	±0.01mS/cm or ±10% (whichever is greater)
Resolution	1 mm	0.1°C	0.001 mS/cm
Range	0 to 3.5 m	-40°C to +50°C	0 - 120 mS/cm (bulk)

PHYSICAL CHARACTERISTICS

<p>SENSOR IMAGE</p>	
<p>SENSOR NAME</p>	<p>CTD Sensor</p>
<p>DIMENSIONS</p>	<p>9 cm X 3.4 cm</p>
<p>CABLE LENGTH*</p>	<p>5 meters</p>

* Custom cable lengths are available for an additional cost.

ELECTRICAL AND TIMING CHARACTERISTICS

PARAMETER	MIN	TYP	MAX	UNITS
Supply Voltage (VCC) to GND	3.6		15	V
Digital Input Voltage (logic high)	2.8	3	3.9	V
Digital Input Voltage (logic low)	-0.3	0	0.8	V
Current Drain (during measurement)	0.5	0.5	1	mA
Current Drain (while asleep)		0.03		mA
Operating Temperature Range	-40		50	°C
Power Up Time (DDI-Serial)			100	mS
Power Up Time (SDI-12)	100	250	300	mS
Measurement duration		250	300	mS
Cable Capacitance / meter		147		pF
Cable Resistance / meter		34		mΩ

EQUIVALENT CIRCUIT DIAGRAM

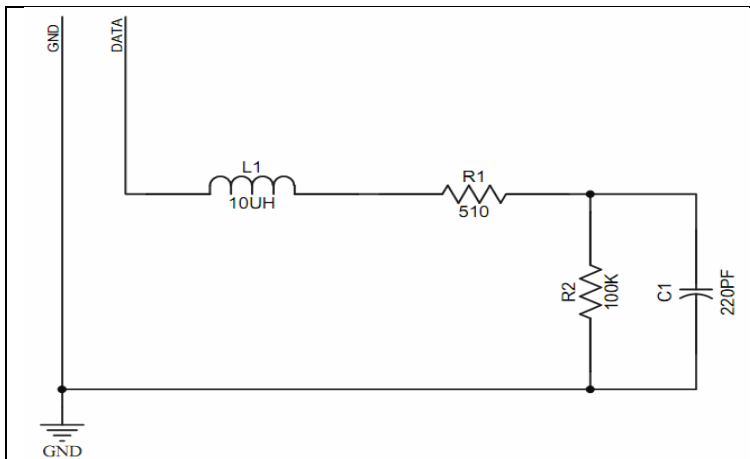

NOTE: This is a low impedance variant of the recommended SDI-12 Specification. This allows up to 62 sensors to be maintained on a bus.

CONNECTION TYPES

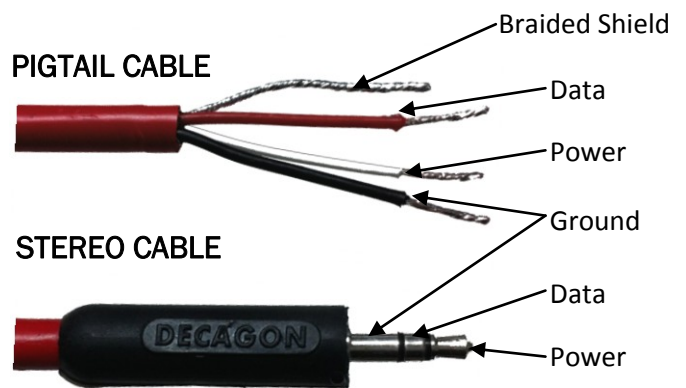

NOTE: The stereo cable option connects the braided shield to the ground line. On the pigtail cable option, the braided shield and ground line are disconnected. They can be connected together if crosstalk is an issue.

⚠ SAFETY PRECAUTIONS

Our probes are built to the highest standards but misuse or improper protection or improper installation may break your sensor and possibly void the manufacturer's warranty. Before integrating your sensors into your sensor network, make sure you have followed the recommended installation instructions and have the proper protections in place to safeguard your sensor from damaging interference.

LIGHTNING AND SURGE PROTECTION

Probes have built in circuitry that protects them against common surge conditions. Installations in lightning-prone areas, however, require special precautions, especially when probes are connected to a well-grounded third party logger.

Visit our website and read the following application note for more information:

[Lightning Surge Suppression And Standard Grounding Practices](#)

POWER AND GROUNDING

Our sensor protection circuitry may be insufficient if your data logger is improperly powered or grounded. Refer to your data logger's installation

instructions. Improper grounding may affect the sensor output as well as the sensor performance.

For Decagon loggers, visit our website and read the following article for more information:

[Lightning Surge Suppression And Standard Grounding Practices](#)

CABLE PROBLEMS

Cable problems can lead to severed cables or disconnected sensors. Rodent damage, driving over sensor cables, tripping over the cable, not leaving enough cable slack during installation or poor sensor wiring connections are just some of many factors that can cause cabling issues.

SENSOR COMMUNICATION TYPES

Decagon digital sensors feature a 1-wire serial interface for communicating sensor measurements. The sensor supports two different protocols: SDI-12 and DDI-Serial. Both interfaces are documented in this guide. Each protocol has advantages and implementation challenges. There are differences in voltage levels, logic levels, and signal timing for each protocol. Please contact Decagon with your specific requirements if the protocol choice for your application is not obvious.

SDI-12 INTRODUCTION

SDI-12 is a standards-based protocol for interfacing sensors to data loggers and data acquisition equipment. Multiple sensors with unique addresses can share a common 3-wire bus (power, ground, and data). Two-way communication between the sensor and logger are possible by sharing the data line for transmit and receive as defined by the standard. Sensor measurements are triggered by protocol command.

DDI-SERIAL INTRODUCTION

The DDI-Serial protocol is the method used by the Decagon's family of data loggers for collecting data from the sensor. This protocol uses the data line configured to transmit data from the sensor to the receiver only (simplex). Typically the receive side is a microprocessor UART or a general-purpose IO pin using a "bit-bang" method to receive data. Sensor measurements are triggered by applying power to the sensor.

INTERFACING THE SENSOR TO A PC

The serial signals and protocols supported by the sensor require some type of interface hardware to be compatible with the serial port found on most personal computers (or USB-to-Serial adapters). There are several SDI-12 interface adapters available in the marketplace; however, Decagon has not tested any of these interfaces and cannot make a recommendation of which adapters work with Decagon sensors. Decagon's Em50 data logger and ProCheck hand-held both are able to operate as a computer-to-sensor interface for making on-demand sensor measurements.

SDI-12 COMMUNICATION

SDI-12 is a common bus communication protocol that allows you to connect multiple sensors to a common data line. The SDI-12 protocol requires a unique alpha numeric sensor address for each sensor on the bus so that a data logger can send and receive readings to specific sensors.

Visit www.sdi-12.org to download the latest SDI-12 Specification or find out more information about the standard.

DECAGON'S SDI-12 IMPLEMENTATION

Decagon's sensors use a low impedance variant of the SDI-12 standard sensor circuit (see the *Equivalent Circuit Diagram*). This allows for up to 62 sensors to be connected onto the bus at one time instead of the 10 that is stated in the standard. Keep in mind that the more sensors you have on a bus, the more difficult it will be to isolate and remove the faulty sensor and restore communication to the remaining sensors on your SDI-12 bus.

Out of the factory, all Decagon sensors start with SDI-12 address zero and print out the DDI-Serial string during the power up time specified in the *Electrical and Timing Characteristics* section (See the start up sequence diagram in the DDI-Serial section for a detailed diagram). This can be interpreted by non-Decagon SDI-12 sensors as a pseudo-break condition followed by a random series of bits. To circumvent this issue, sensors with firmware version 3.46 and newer omit the DDI-Serial string when their SDI-12 address is non-zero. Simply changing the sensor addresses on the SDI-12 bus to non-zero values will prevent any race conditions on the data line during sensor power up.

After the power up time, our sensors are fully compatible with all the commands listed in the SDI-12 Specification v1.3 except for the continuous measurement commands (aR0 – aR9 and aRC0 – aRC9).

SENSOR BUS CONSIDERATIONS

An SDI-12 bus isn't something you can set up and just walk away. Sensor buses require regular checking, sensor upkeep, and sensor trouble-shooting. If one sensor goes down, that may take down the whole bus even if the remaining sensors are functioning normally. Power cycling the SDI-12 bus when a sensor is failing is okay but we do not recommend scheduling power cycling events on an SDI-12 bus more than once or twice a day.

Many factors influence the effectiveness of your bus configuration and many questions should be answered: How often should data be checked? How is the data delivered to the end user? How do I isolate a faulty sensor?

Visit our website and read our application note and view our virtual seminars on *Best Practices for SDI-12 Sensor Networks*.

SDI-12 TIMING

SDI-12 communication sends characters at 1200 bits per second. Each character has 1 start bit, 7 data bits (LSB first), 1 even parity bit, and 1 stop bit (Active low or inverted logic levels):

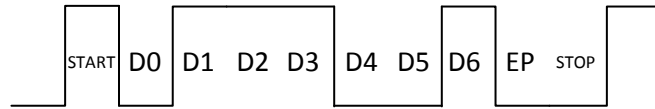

Example SDI-12 transmission of the character '1' (0x31)

All SDI-12 commands and response must adhere to the following format on the data line. Both the command and response are preceded by an address and terminated by a carriage return line feed combination.

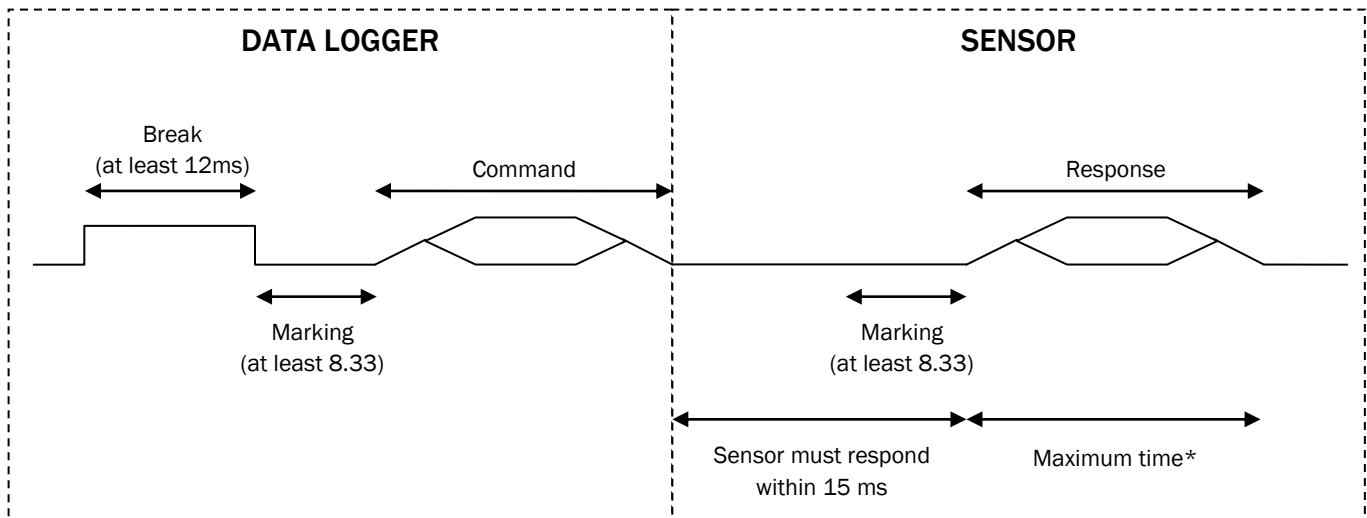

***MAXIMUM TIME**

380 mS	Most Commands
780 mS	For a D command after a concurrent measurement
810 mS	For a D command after a concurrent measurement, with CRC

COMMON SDI-12 COMMANDS

Below is a list of common SDI-12 commands that are often used in an SDI-12 system and the corresponding responses from our sensors:

INFO COMMAND (aI!)

The information command can be used to obtain a variety of detailed information about the sensor you are connected to. Here is an example output from one of our sensors (the logger command is in **bold**):

1I!113DECAGON CTD 343631800001

PARAMETER	FIXED LENGTH*	DESCRIPTION
1I!	3 Chars	Request from the data logger asking for information from sensor address 1.
1	1 Char	Sensor Address. Pre-pended on all responses, this allows you to know which sensor on your bus is returning the following information.
13	2 Chars	Indicates that the target sensor supports SDI-12 Specification v1.3 (2 characters)
DECAGON	8 Chars	The Vendor Identification String. The parameter is the same for all our Decagon sensors.
CTD	6 Chars	The Sensor Model String. This string is specific to the sensor type. For CTD Sensors, the string is "CTD"
343	3 Chars	The Sensor Version. This number is divided by 100 to give our sensor version. In this case the Decagon sensor version is 3.43
631800001	Up to 13 Chars	The Sensor Serial Number. The is a variable length field. For older sensors this may be omitted. Newer sensors may contain serial number information here.

* In the event that the fixed length is longer than the parameter, the trailing characters will be populated with space characters.

MEASUREMENT COMMAND† (aM!)

The measurement command can be used to begin a sensor measurement. Here is an example output from one of our sensors (the logger command is in **bold**):

1M!10013

PARAMETER	FIXED LENGTH	DESCRIPTION
1M!	3 Chars	Request from the data logger asking the sensor with address 1 to begin a measurement
1	1 Char	Sensor Address. Pre-pended on all responses, this allows you to know which sensor on your bus is returning the following information.
001	3 Chars	The measurement data will be available after this specified time in seconds. If a sensor finishes early, it will initiate a service request (SDI-12 address and a return character line feed).
3	1 Char	Number of values that will be returned.

† The measurement and corresponding data command are intended to be used back to back. If you would like to start a measurement on more than one sensor at a time, you must use the concurrent command. See the SDI-12 Specifications v1.3 document for more information.

DATA COMMAND† (aD0!)

The data command is used to retrieve the measurement response from the sensor. Each value is delimited by the sign of the value that can be either positive or negative. Here is an example output from one of our sensors (the logger command is in **bold**):

1D0!1+542+22.3+645

PARAMETER	FIXED LENGTH	DESCRIPTION
1D0!	4 Chars	Request from the data logger asking the sensor with address 1 to return the response from a measurement. (A measurement command must be sent prior to sending the data command).
1	1 Char	Sensor Address. Pre-pended on all responses, this allows you to know which sensor on your bus is returning the following information.
+542	Variable	Water / reservoir depth measurement in millimeters of H ₂ O (at the specified temperature).
+22.3	Variable	Temperature measurement in °C
+645	Variable	Bulk Electrical Conductivity measurement in µS/cm.

† The measurement and corresponding data command are intended to be used back to back. If you would like to start a measurement on more than one sensor at a time, you must use the concurrent command. See the SDI-12 Specifications document for more information.

CHANGE ADDRESS COMMAND (aAb!)

The change address command is used to change a sensor’s address to a new address. All other commands support the wild card character as the target sensor address except for this command. All of Decagon’s sensors have a default address of 0 (zero) out of the factory. In order to use more than one of our sensors on a bus system, you must change the addresses so that they are all unique. Supported addresses are alpha numeric (i.e. a – z, A – Z, and 0 – 9). Changing address while connected to a bus is not recommended. Here is an example output from one of our sensors (the logger command is in **bold**):

1A0!0

PARAMETER	FIXED LENGTH	DESCRIPTION
1A0!	4 Chars	Request from the data logger asking the sensor to change the address of sensor with address 1 to a new address of 0 (zero).
0	1 Char	New Sensor Address. For all subsequent commands, this new address will be used for the target sensor.

ADDRESS QUERY COMMAND (?!)

While disconnected from a bus, the address query command can be used to determine which sensor you are currently communicating with. Sending this command over a bus will cause a bus contention where all the sensors will respond simultaneously and corrupt the data line. This command is helpful if you are trying to isolate a failed sensor. Here is an example output from one of our sensors (the logger command is in bold):

?!0

PARAMETER	FIXED LENGTH	DESCRIPTION
?!	2 Chars	Request from the data logger asking for a response from any sensor listening on the data line.
0	1 Char	Sensor Address. Returns the sensor address to the currently connected sensor.

DDI-SERIAL COMMUNICATION

The DDI-Serial communications protocol is ideal for systems that have dedicated serial signaling lines for each sensor or use a multiplexer to handle multiple sensors. The serial communications are compatible with many TTL serial implementations that support active-high logic levels using 0-3.6 volts signal levels. When the sensor is first powered, it automatically makes measurements of the integrated transducers then outputs a response over the data line. Systems using this protocol control the sensor excitation to initiate data transfers from the sensor. This protocol is subject to change as Decagon improves and expands our line of digital sensors and data loggers.

NOTE: Out of the factory, all Decagon sensors start with SDI-12 address zero and print out the startup string when powered cycled. On sensors with firmware version 3.46 and newer the start up string is omitted when the address is non-zero.

DDI-SERIAL TIMING

DDI-serial communication sends characters at 1200 bits per second. Each character has 1 start bit, 8 data bits (LSB first), no parity bit, and 1 stop bit. (Active high or non-inverted logic levels)

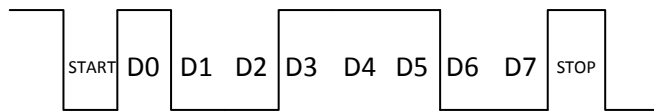

Example serial transmission of the character '9' (0x39)

Upon power up, the sensor will pull the data line high within 100 mS to indicate that the sensor is taking a reading. When the reading is complete, the sensor begins sending the serial signal out the data line. Once the data is transmitted, the sensor goes into SDI-12 communication mode. In order to get another serial signal, the sensor must be power cycled.

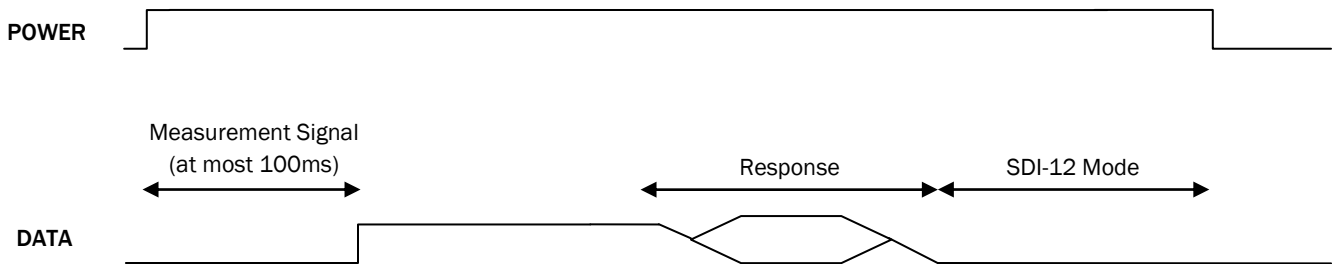

Note: Sometimes the signaling from the sensor can confuse typical microprocessor UARTs. The sensor holds the data line low while it takes measurements. It raises the line high to signal the logger that it will send a measurement as documented above. Then the sensor may take some additional measurements before starting to clock out the first data byte starting with a typical start bit (low). Once the first start bit is sent, typical serial timing is valid; however, the signal transitions before this point are not serial signaling and may be misinterpreted by the UART.

DDI-SERIAL RESPONSE

The data string output by the sensor should be in a format similar to the one below:

```
<09>542 22.3 245<0D>t%<0D><0A>
```

Section **Description**

PARAMETER	DESCRIPTION
<09>	Tab character signaling the start of the data transmission.
542	Pressure in millimeters. Values will typically range from 0 to 4000 mm. In this example, 542 indicates that the sensor is measuring a water depth of 542 mm.
22.3	Temperature. This number is the temperature of the sensor in degrees Celsius. In this example, 22.3 indicates that the sensor is measuring a temperature of 22.3°C.
245	Electrical conductivity in $\mu\text{S}/\text{cm}$. Divide this number by 1000 to get mS/cm (or mS/cm). This value is already temperature corrected within the sensor using the temperature correction outlined by the US Salinity labs Handbook 60. Raw values for EC in tap water can range from 100 to 800 (0.1 to 0.8 mS/cm). In this example, 245 $\mu\text{S}/\text{cm}$ is the raw bulk electrical conductivity reported. Dividing by 1000 gives a value of 0.245 mS/cm .
<0D>	This carriage return character signals the end of the measurement string and start of the meta data string.

Everything below is this line is meta data:

t	Sensor Type. This character is used to indicate the sensor type. t is used for CTD sensors, and u is used for G3DG sensors.
%	Checksum. This one character checksum is used in our instruments to ensure that the data transmitted are valid. The checksum is used for sections listed above: <09>542 22.3 245<0D>t See the following function for an example of how to implement the checksum algorithm in C.
<0D><0A>	The carriage return and line feed are used to signal the end of the meta data section and the end of the transmission.

DDI-SERIAL CHECKSUM

Here is an example of how to calculate the checksum (crc) in C. In this case, the string passed to the function would be: "<09>542 22.3 245<0D>t" and the returning value would be the character '%'.

```
char CalculateChecksum(char * Response){
    int length, sum = 0, i, crc;

    // Finding the length of the response string
    length = strlen(Response);

    // Adding characters in the response together
    for( i = 0; i < length; i++ )
        sum += Response[i];

    // Converting checksum to a printable character
    crc = sum % 64 + 32;

    return crc;
}
```